

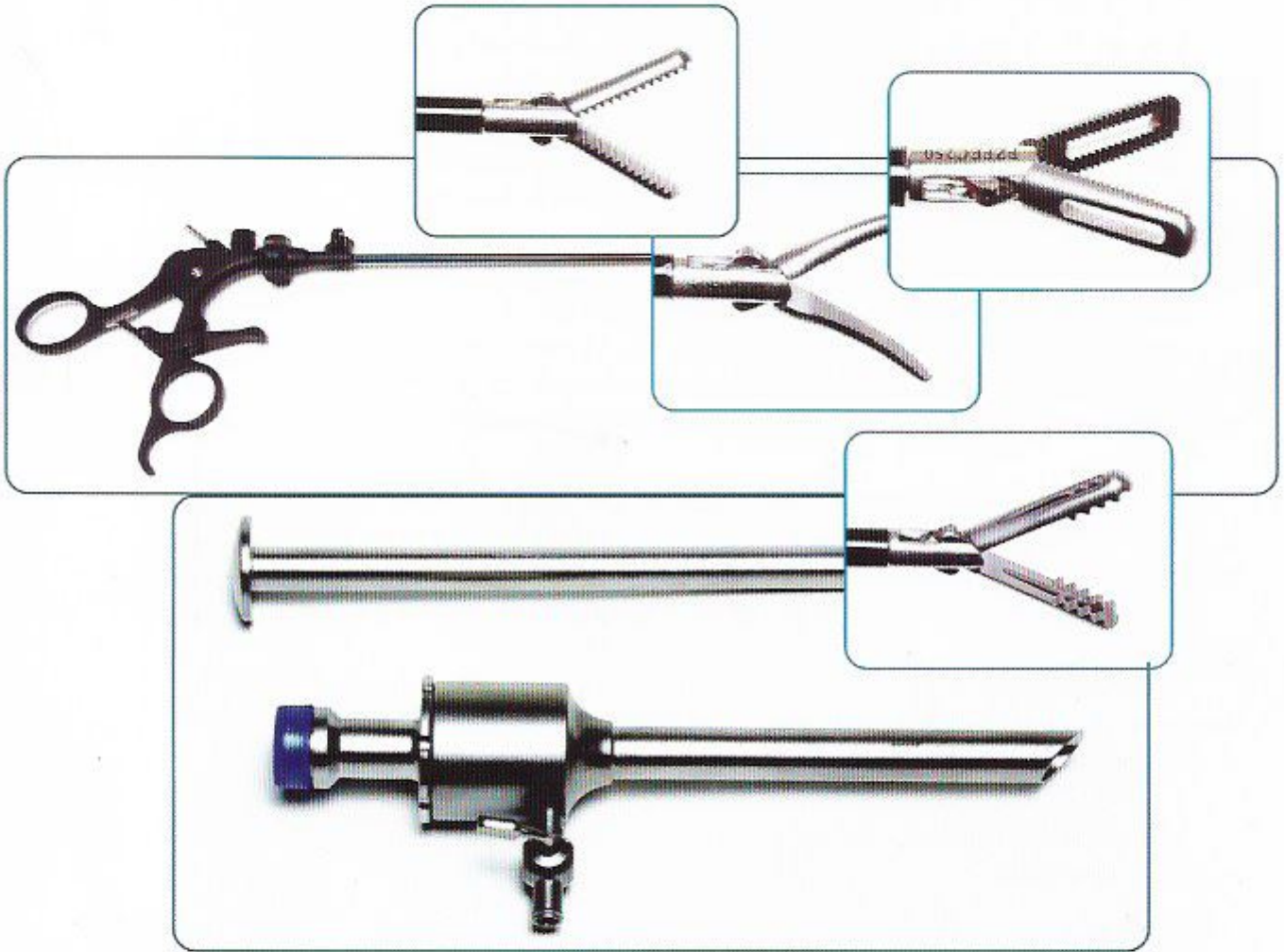

# ENDOSCOPY





ENDOSCOPY



ENDOSCOPY

Av. Rivadavia 1479 6° B  
(54-11) 4383-0309/5440  
[info@endoscopy.com.ar](mailto:info@endoscopy.com.ar)

	PAG.
PINZAS DE 5MM 33CM	5 A 7
PINZAS DE COLANGIOGRAFIA	8
PINZAS DE 3,5MM 20CM	8
PINZAS DE 3,5MM 33CM	9
PINZAS DE 5MM 42CM	9
PINZAS DE 10MM 33CM	10
PINZAS MONOPUERTO	11
TIJERAS 10MM 33CM	11
TIJERAS 5MM 42CM	11
TIJERAS 5MM 33CM	12
TIJERAS 3,5MM 20CM Y 33CM	12
PINZAS CLIPADORAS 5MM	13
PINZAS CLIPADORAS 10MM	13
PINZAS BIPOLARES	14
PORTAAGUJAS	15
CANULAS DE VERRES	16
CANULAS DE DISECCIÓN	16
VAINAS Y TRÓCARES DE 3,5MM	17
VAINAS Y TRÓCARES DE 5MM	17
VAINAS Y TRÓCARES DE 10MM	18, 19
VAINAS Y TRÓCARES DE 12MM	20
VAINAS Y TRÓCARES DE 15MM	20
REDUCTORES	20
VAINAS Y TRÓCARES PARA CIRUGÍA DE TÓRAX	21
VAINAS Y TRÓCARES PARA ARTROSCOPIA	21
MOVILIZADOR UTERINO	22
CANULAS DE ASPIRACION E IRRIGACION	22
SEPARADORES	23
BAJANUDOS	24
OPTICAS	25
CABLES, CABLES DE FIBRA ÓPTICA	26
HISTEROSCOPIO	27
RECEPTOSCOPIO	28
REPUESTOS	29, 30



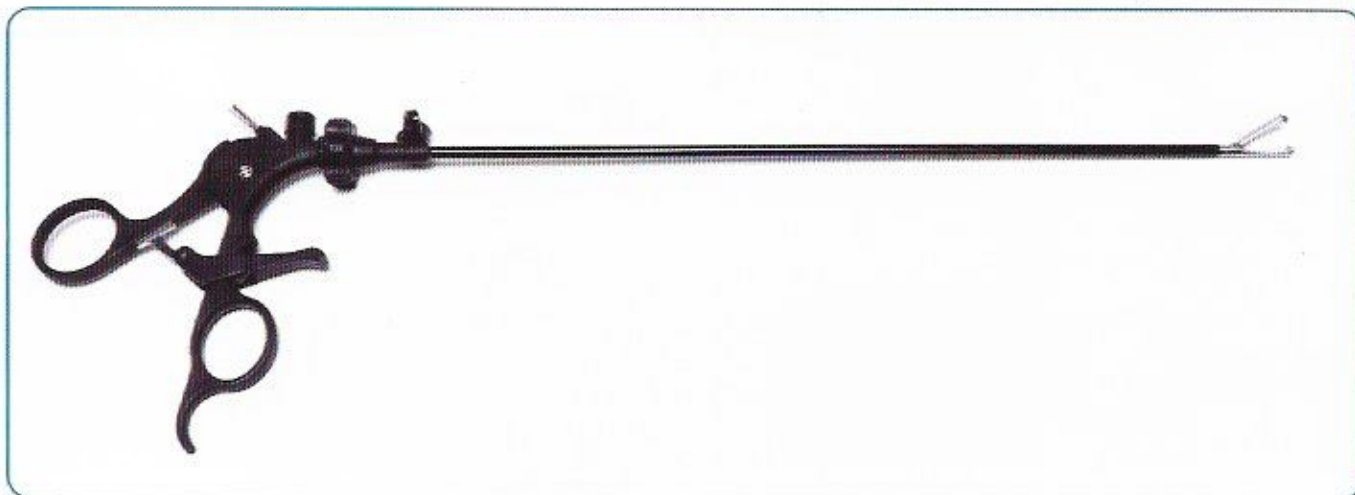

**PZFEC 250**

Pinza Fenestrada Corta, aislada, giratoria, doble acción

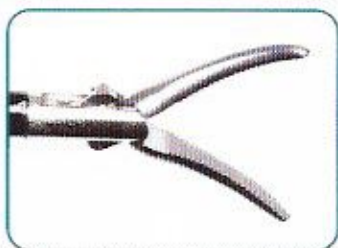

**PZDMY 250**

Pinza Maryland de Disección, giratoria, aislada, sin cremallera, doble acción

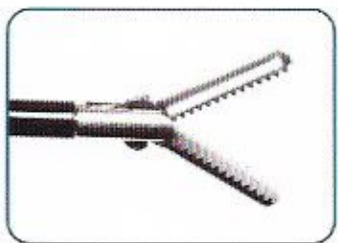

**PZAAL 250**

Pinza de Aprehensión Larga, aislada, giratoria, doble acción

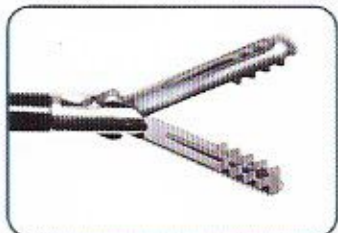

**PZAEV 250**

Pinza de Aprehensión Dentada, especial para vesícula, con cremallera

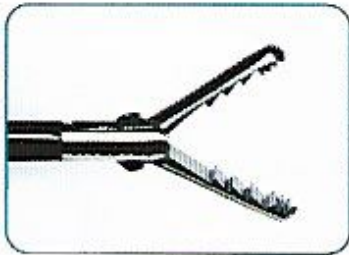

**PZAED 250**

Pinza de Aprehensión y Extracción, dentada, con cremallera



**PZDAL 250**

Pinza Delicada, tipo Allis, aislada, sin cremallera, doble acción



**PZDX3 250**

Pinza Dentada en Garra, extractora 2x3 dientes simple acción



**PZAX3 250**

Pinza de Aprehensión Dentada en Garra, extractora 2x3 dientes, doble acción, aislada



**PZAAS 250**

Pinza Atraumática, aislada, giratoria, doble acción

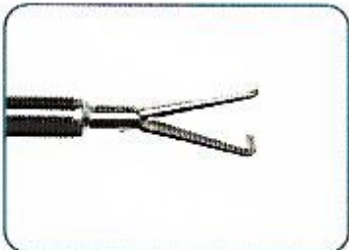

**PZD90 250**

Pinza de Disección a 90°, aislada, giratoria, doble acción

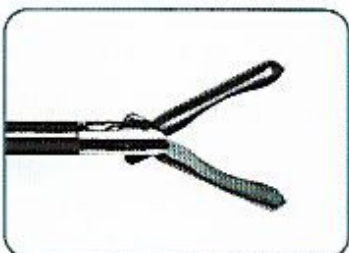

**PZAAP 250**

Pinza de Aprehensión Atraumática Plana, doble acción, aislada

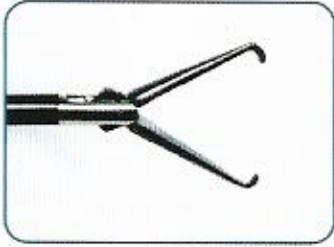
**PZAPM 250**

Pinza de Aprehensión para Mioma, aislada, giratoria, doble acción

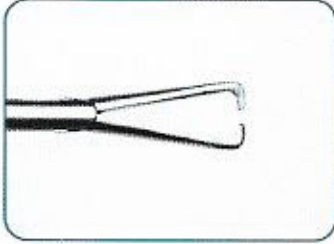
**PZAPM 251**

Pinza de Aprehensión para Mioma, aislada, giratoria, doble acción, mango metálico

**PZDDC 250**

Pinza de Disección Dentada, curva, fenestrada doble acción

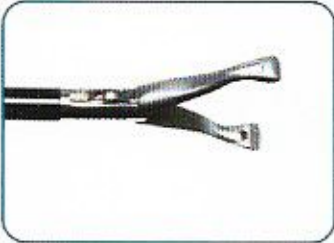
**PZBAA 250**

Pinza Babcock, con cremallera, aislada, giratoria, doble acción

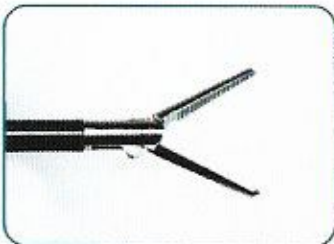
**PZDMR 250**

Pinza Atraumática de Disección, estriada, recta

**PZBIO 250**

Pinza para Biopsia 1x1 Diente, aislada, giratoria, doble acción

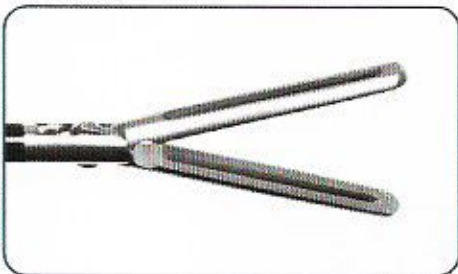
**PZFEL 250**

Pinza Fenestrada Larga, aislada, giratoria, doble acción

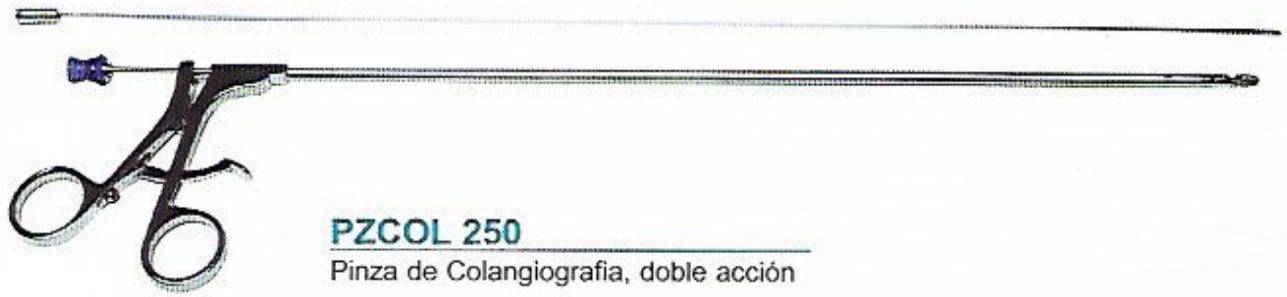
**PZCOL 250**

Pinza de Colangiografía, doble acción

## PINZAS DE 3,5MM 20CM

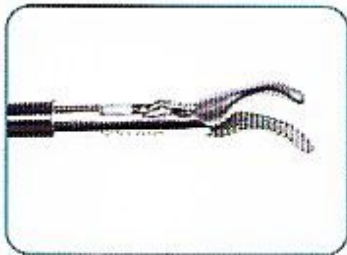
**PZDMY 230**

Pinza Maryland de disección, giratoria, aislada, sin cremallera, doble acción

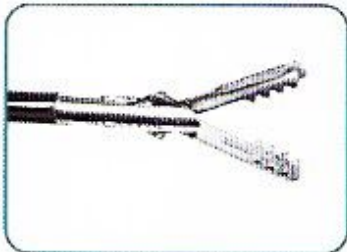
**PZAEV 230**

Pinza de Aprehensión Dentada, especial para vesícula, con cremallera



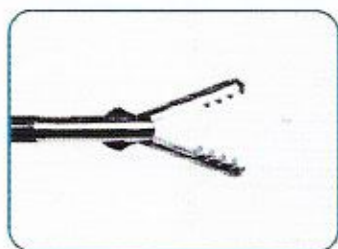

**PZAEV 231**

Pinza de Aprehensión Dentada, especial para vesícula, con cremallera

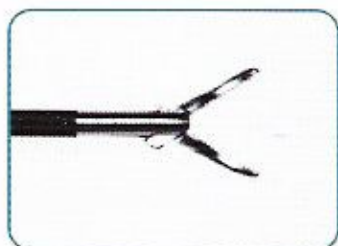

**PZDMY 231**

Pinza Maryland de Disección, giratoria, aislada, sin cremallera, doble acción

PINZAS DE 5MM 42CM

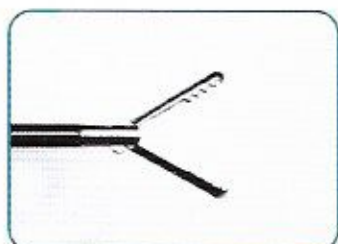

**PZAEV 251**

Pinza de Aprehensión Dentada, especial para vesícula, con cremallera

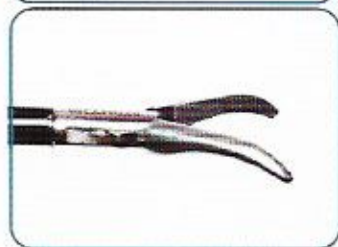

**PZDMY 251**

Pinza Maryland de Disección, giratoria, aislada, sin cremallera, doble acción

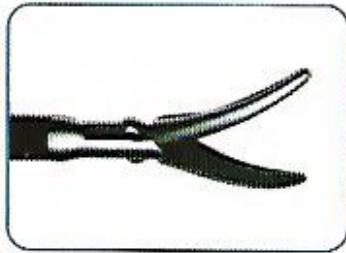
**PZDMY 210**

Pinza Maryland para órganos gruesos, aislada, giratoria, doble acción

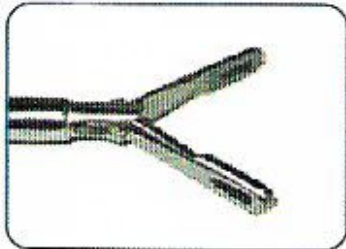
**PZATL 210**

Pinza Atraumática larga, aislada, giratoria, doble acción

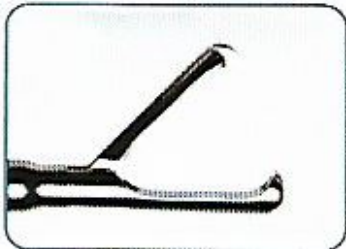
**PZDX3 210**

Pinza Dentada en Garra, 2x3 dientes, aislada, con cremallera

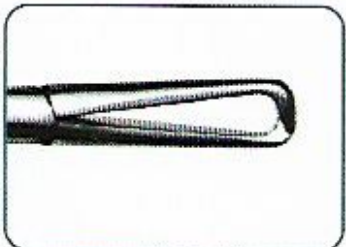
**PZAPM 210**

Pinza de Aprehensión para Mioma, mango metálico

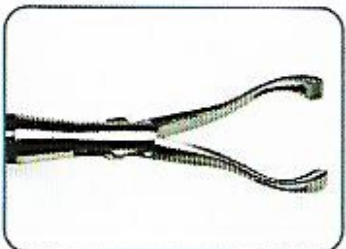
**PZBAA 210**

Pinza Babcock, aislada, giratoria, doble acción

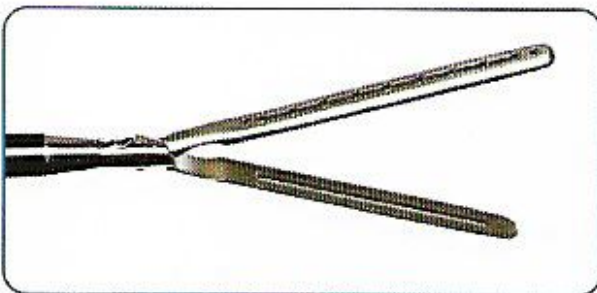
**PZFEL 210**

Pinza Fenestrada Larga, aislada, giratoria, doble acción

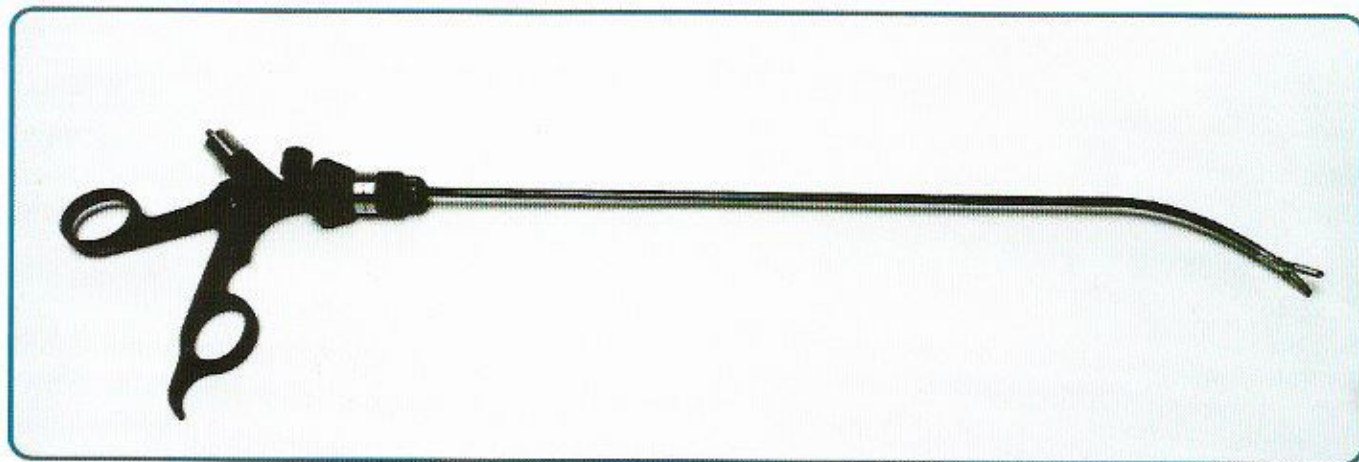

**PZFMP 250**

Pinza Fenestrada Monopuerto, aislada, giratoria, doble acción



**PZMMP 250**

Pinza Maryland Monopuerto, aislada, giratoria, doble acción

TIJERAS 10MM 33CM



**TJREC 210**

Tijera Recta, giratoria, doble acción

TIJERAS 5MM 42CM



**TJCUR 251**

Tijera de Metzenbaum Curva, giratoria, aislada, doble acción



**TJCUR 250**

Tijera de Metzenbaum Curva, giratoria, aislada, doble acción

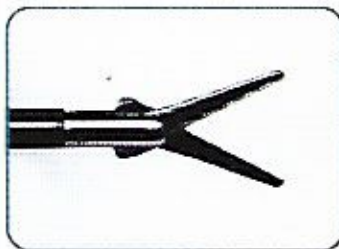

**TJREC 250**

Tijera Recta, giratoria, doble acción

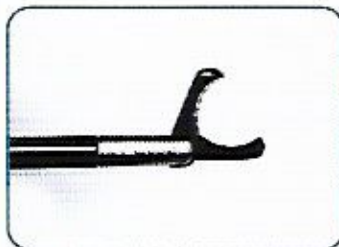

**TJHOK 250**

Tijera Hook, giratoria, aislada, doble acción

**TIJERAS 3,5MM 20CM y 33CM**

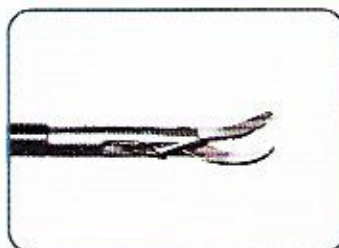

**TJCUR 230**

Tijera de Metzenbaum Curva, giratoria, aislada, doble acción, 20 cm

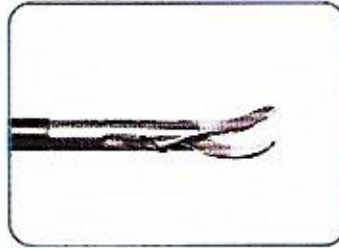

**TJCUR 231**

Tijera de Metzenbaum Curva, giratoria, aislada, doble acción, 33 cm

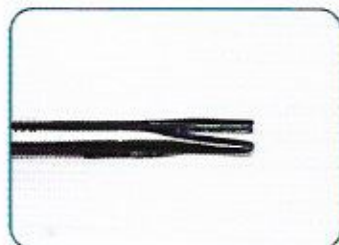
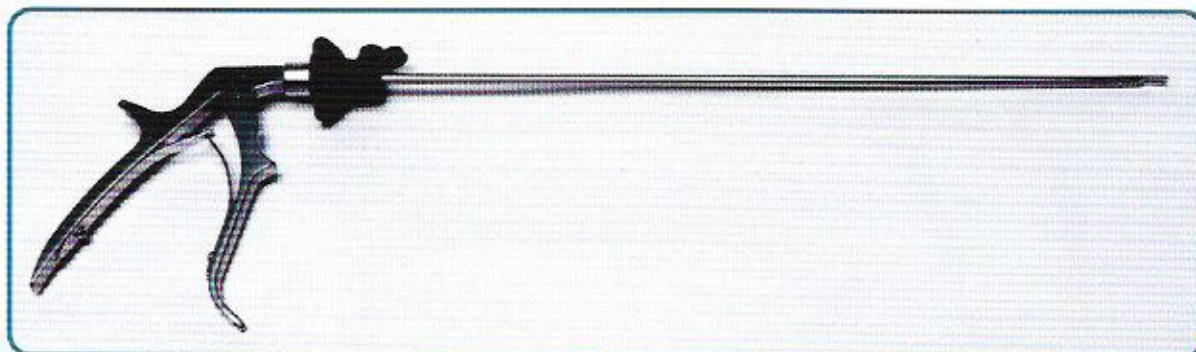

**PZCLI 250**  
Pinza Aplicadora de Clips  
simple acción, mango  
metálico

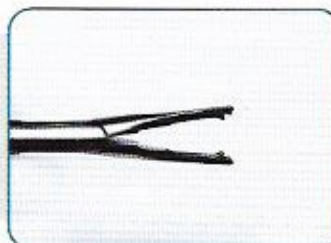

**PZCLP 250**  
Pinza Aplicadora de Clips  
Plásticos, mango metálico

**PINZAS CLIPADORAS 10MM**

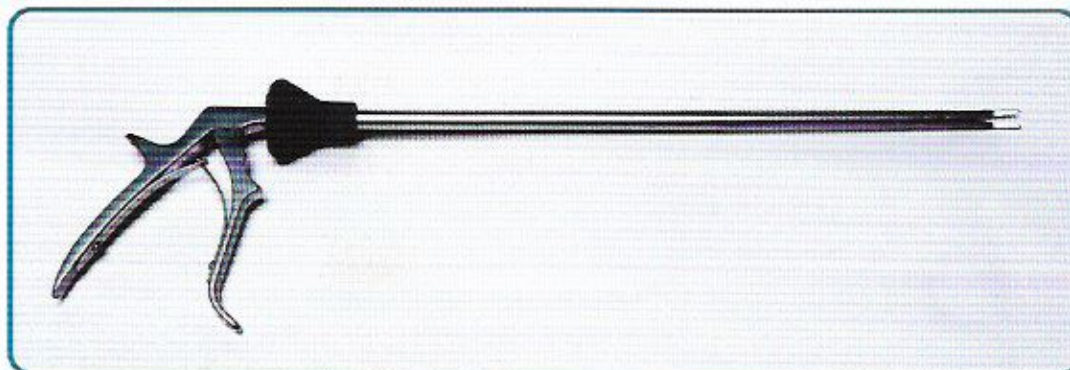

**PZCLI 210**  
Pinza Aplicadora de Clips  
doble acción

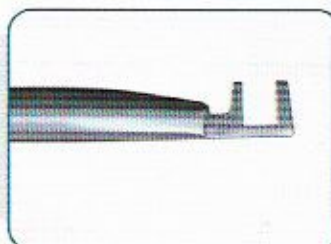

**PZC90 210**  
Pinza Aplicadora de Clips  
a 90° simple acción

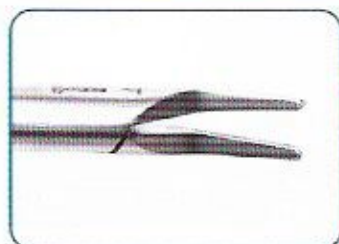

**PZCLI 211**  
Pinza Aplicadora de Clips  
simple acción

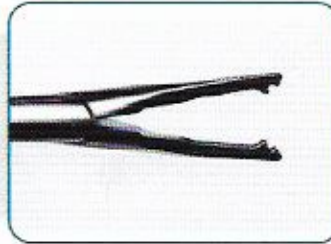

**PZCLP 210**  
Pinza Aplicadora de Clips  
Plásticos Grande, mango  
metálico

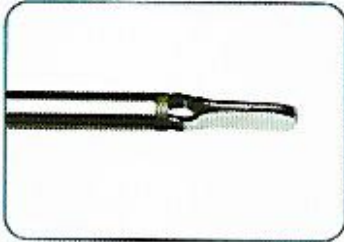
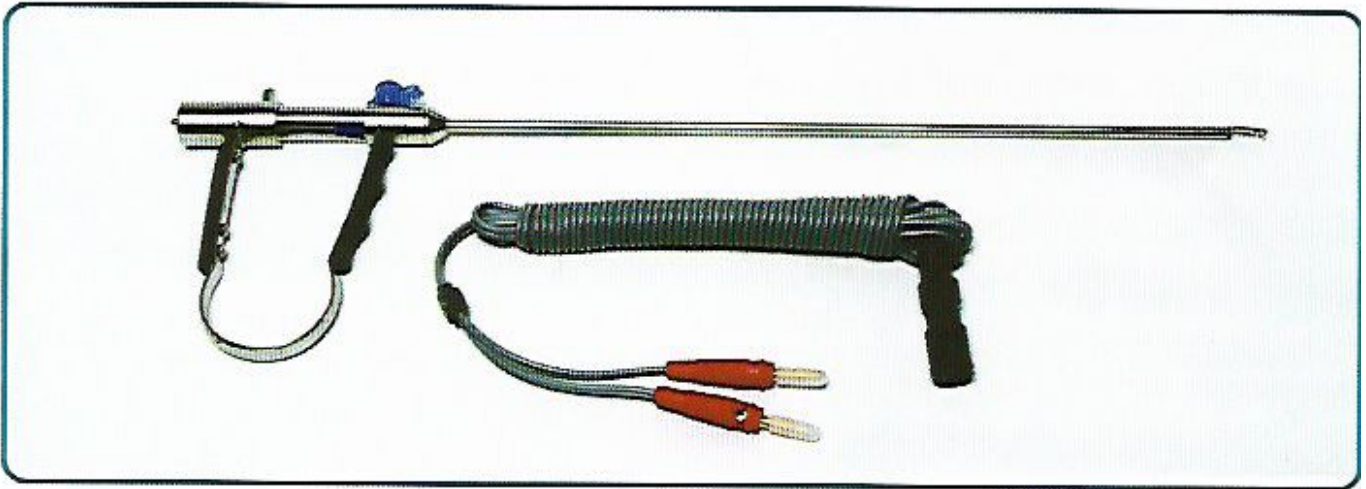

**PZBIU 250**

Pinza de Aprehensión Bipolar Agarre en U, con cable

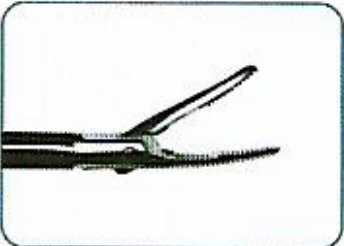
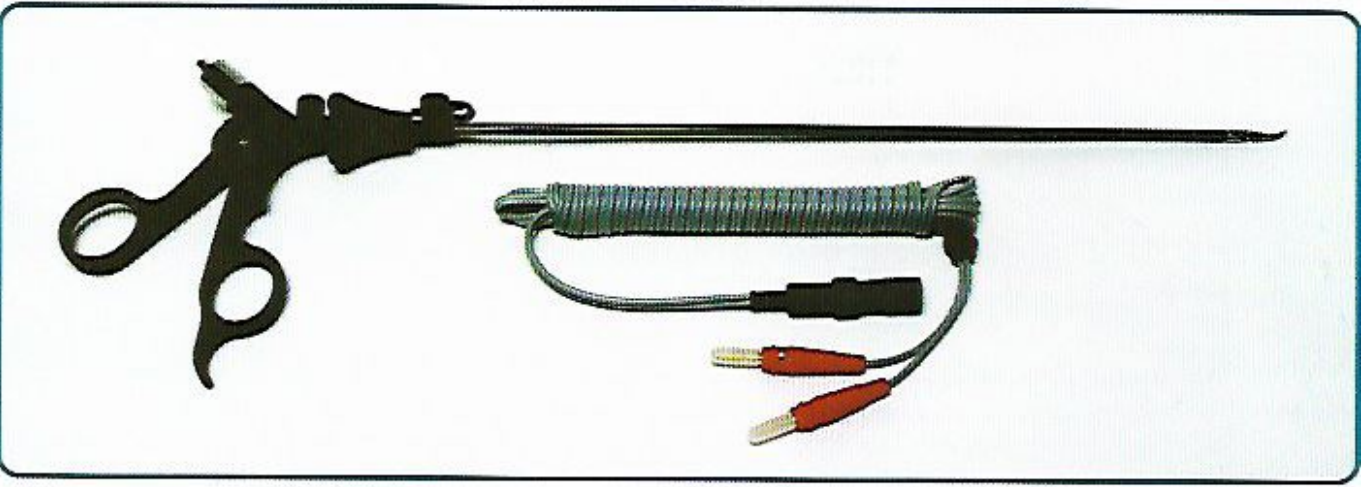

**PZBIM 250**

Pinza Bipolar Maryland, con cable



**PZBIF 250**

Pinza de Aprehensión Bipolar Fenestrada con cable

**Porta Agujas mango con anillas**

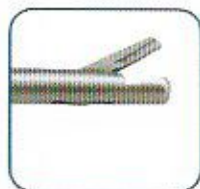
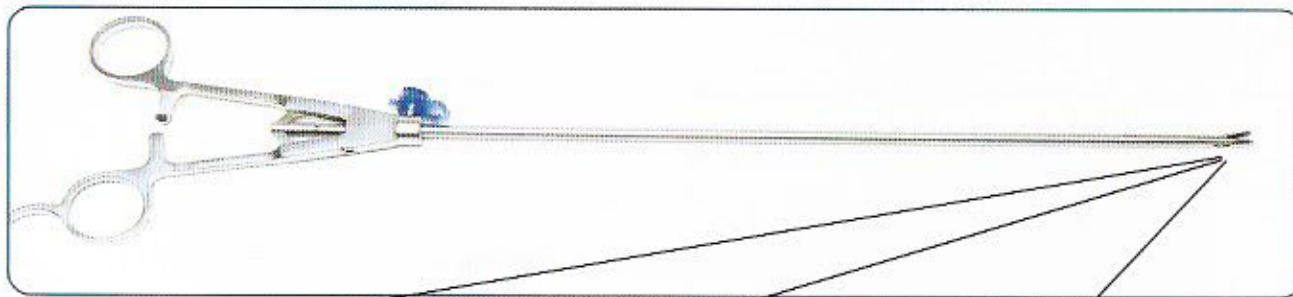

**PAGMA 250**  
Porta Agujas  
acomoda aguja  
mango con anillas



**PACMA 250**  
Porta Agujas  
curvo mango con  
anillas



**PARMA 250**  
Porta Agujas recto  
mango con anillas

**Porta Agujas mango curvo**

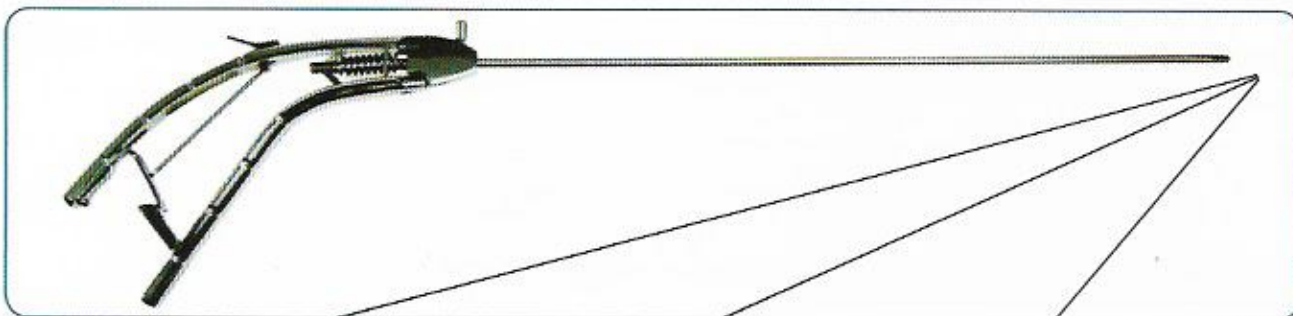

**PAGMC 250**  
Porta Agujas  
acomoda aguja  
mango curvo



**PACMC 250**  
Porta Agujas curvo  
mango curvo



**PARMC 250**  
Porta Agujas recto  
mango curvo

**Porta Agujas mango recto**

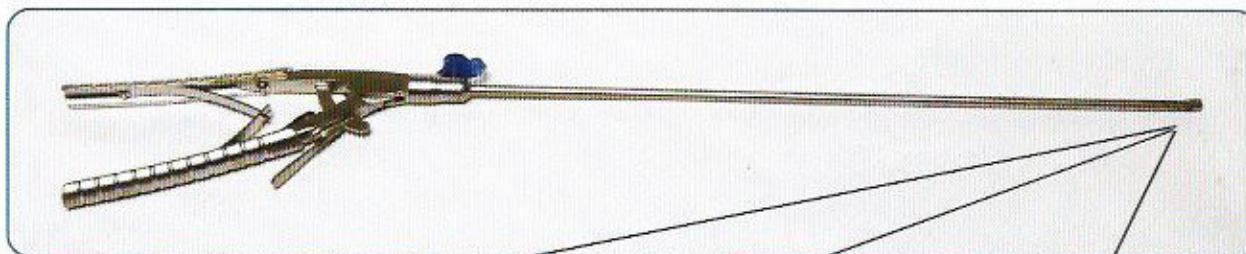

**PAGMR 250**  
Porta Agujas  
acomoda aguja  
mango recto



**PACMR 250**  
Porta Agujas  
curvo mango  
recto



**PARMR 250**  
Porta Agujas  
recto mango  
recto

**CNVER 208 - 212 - 215 - 217**

Cánula para Pneumoperitoneo de VERRES, con protección retráctil, de 8, 12, 15 y 17 cm

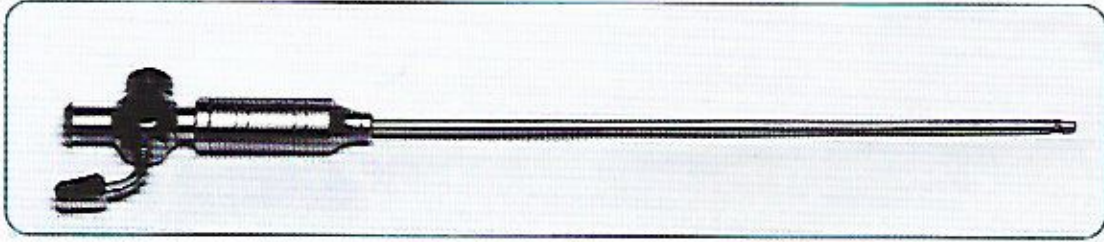
**CANULAS DE DISECCIÓN****CNHKL 250**

Cánula de Disección Hook en L 5 mm

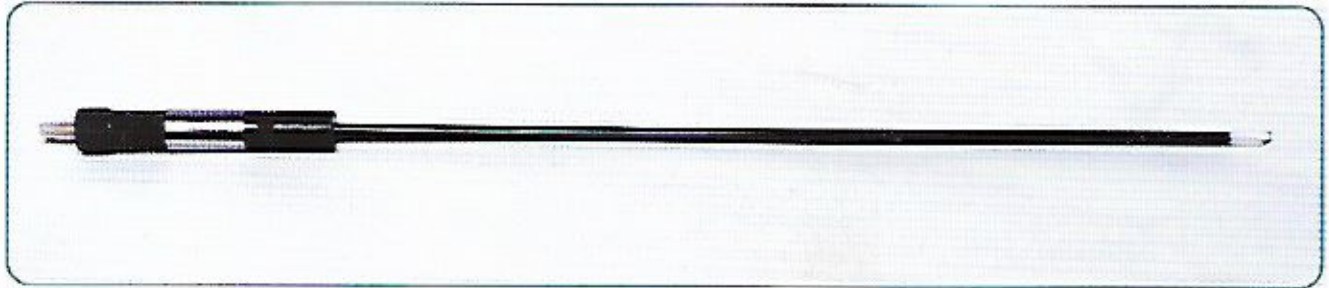
**CNHLB 250**

Cánula de Disección Hook en L Bipolar

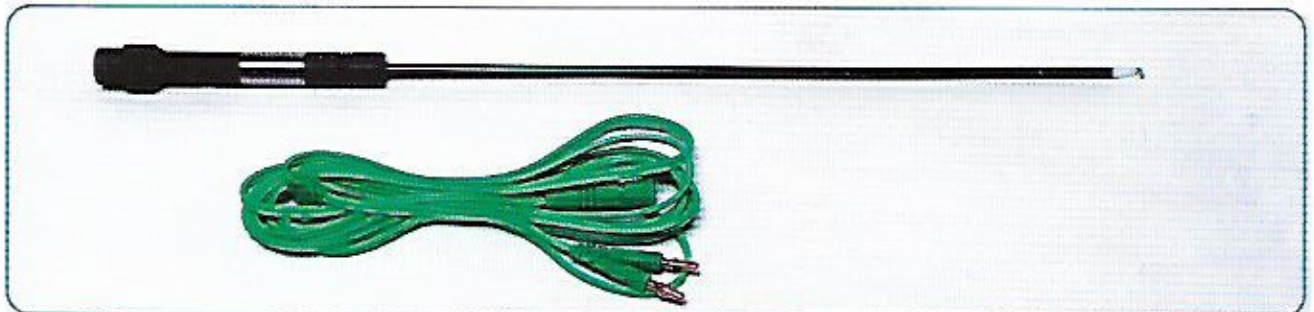



**VACO2 231**

Vaina con válvula para CO2 y trocar de 3,5 mm

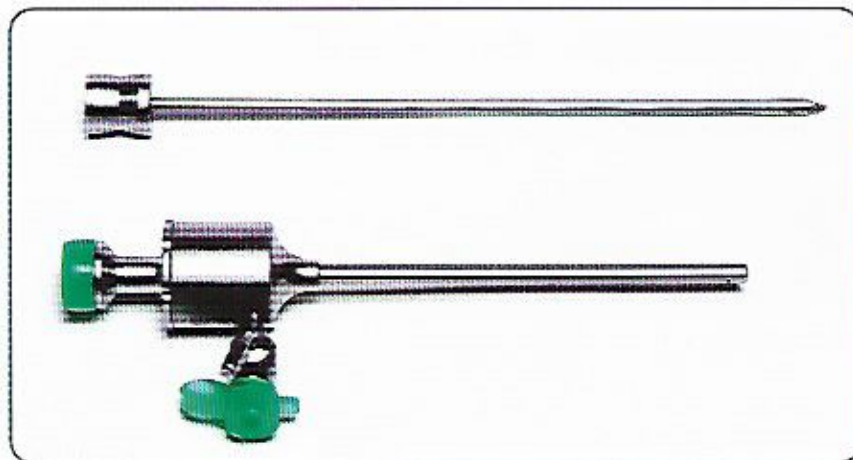
**VAINAS y TRÓCARES DE 5MM****VACO2 251**

Vaina con válvula para CO2 y trocar punta piramidal

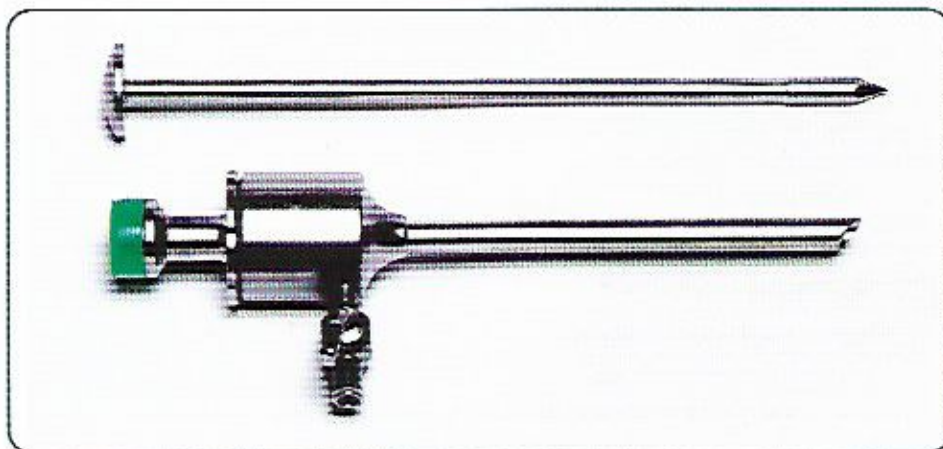
**VACOP 151**

Vaina con válvula para CO2 y trocar punta de seguridad

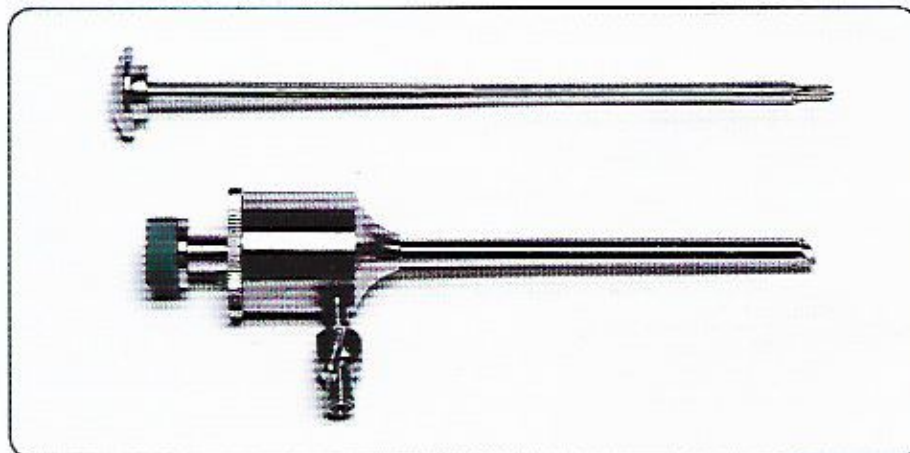

**VAMAG 151** Vaina con cierre magnético con válvula para CO2 y trocar deseguridad

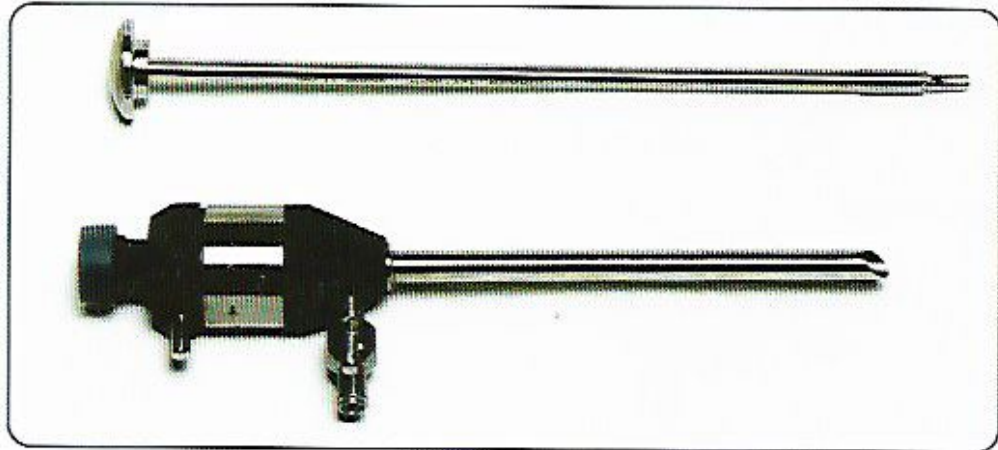

### VAINAS y TRÓCARES DE 10MM

**VACO2 211** Vaina con válvula para CO2 con cierre tipo ventana y trocar punta piramidal 10 mm

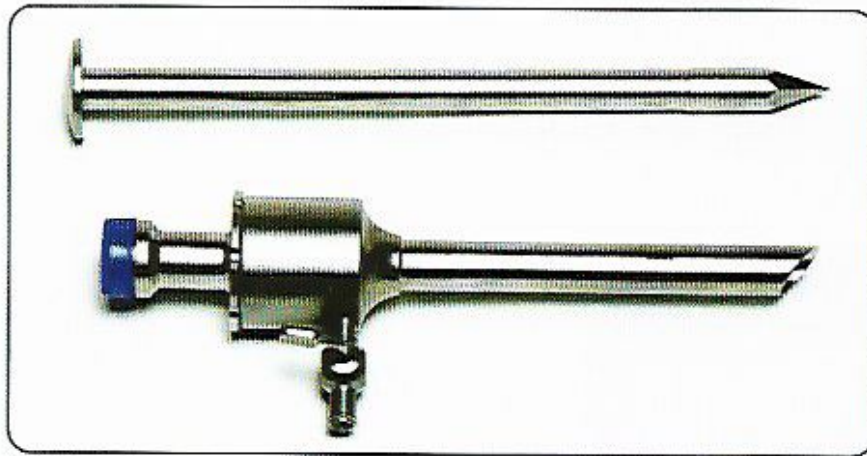

**VACOP 111** Vaina con válvula para CO2 con cierre tipo ventana y trocar punta de seguridad 10 mm

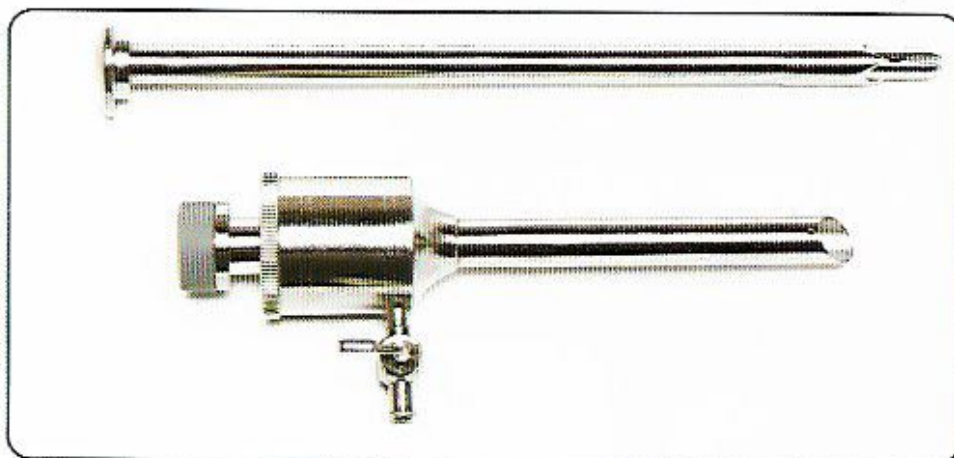

**VAMAG 211** Vaina con válvula para CO2 con cierre magnético tipo moneda y trocar piramidal

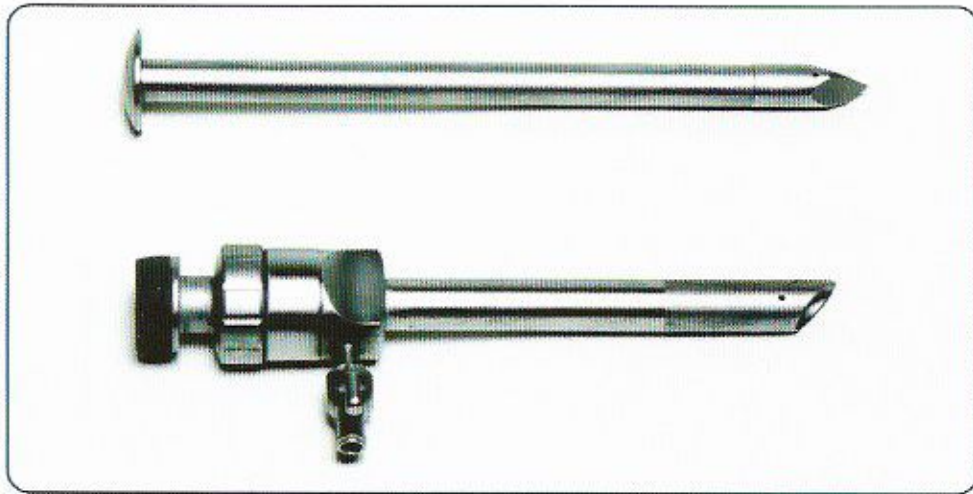

**VAMAG 111** Vaina con válvula para CO2 y trocar punta de seguridad

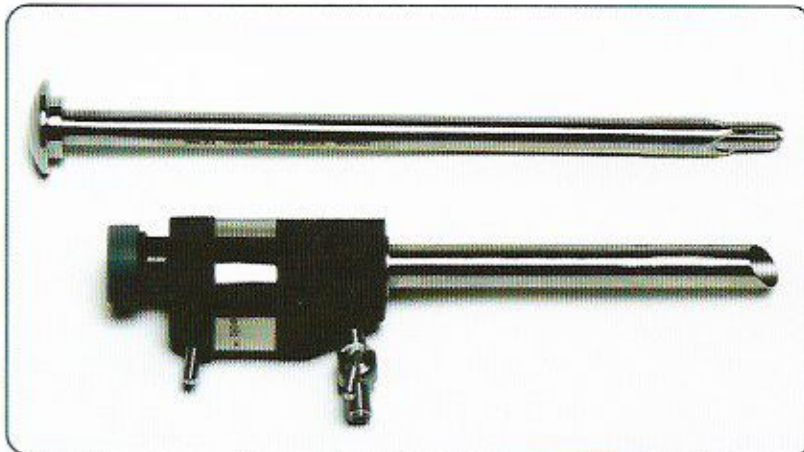

**VACOE 211** Vaina con válvula para CO2 con tubo en espiral y trocar de 10 mm

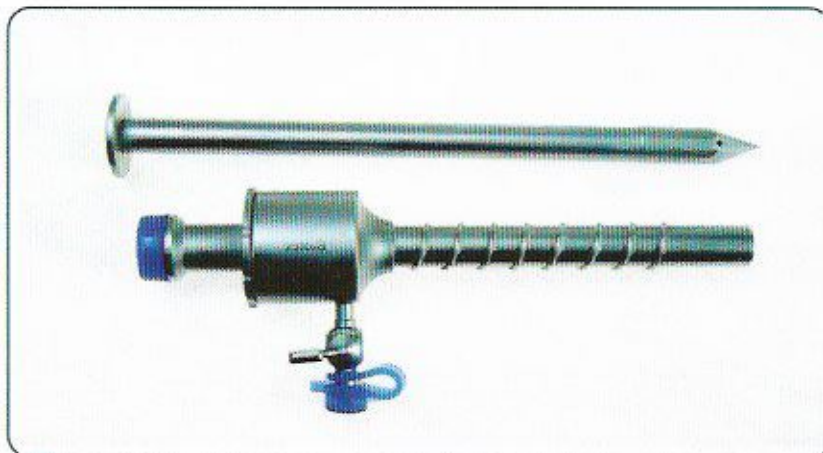

**VACO2 221** Vaina con válvula para CO2 cierre tipo ventana y trocar punta piramidal 12,5 mm

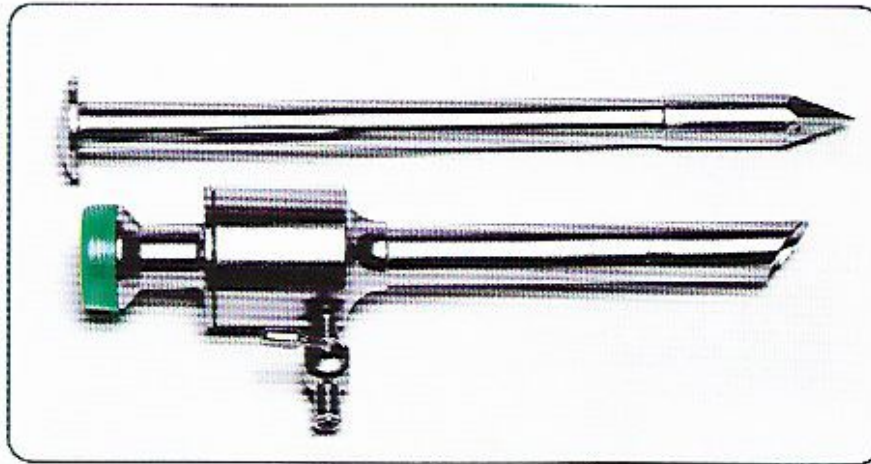
**VAINAS y TRÓCARES DE 15MM**

**VAMAG 215** Vaina con cierre magnético con válvula para CO2 y trocar de 15,5mm

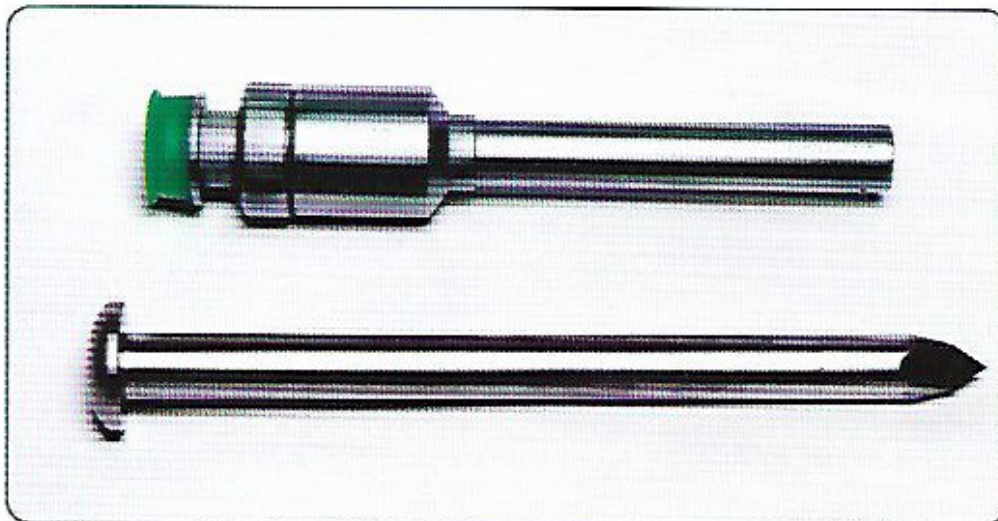
**REDUCTORES**

**CNRED 110** Reductor / Extractor de 10 a 5 mm, 10 cm



**VACTX 211**

Vaina para Cirugía de Tórax y trocar de 10,5 mm

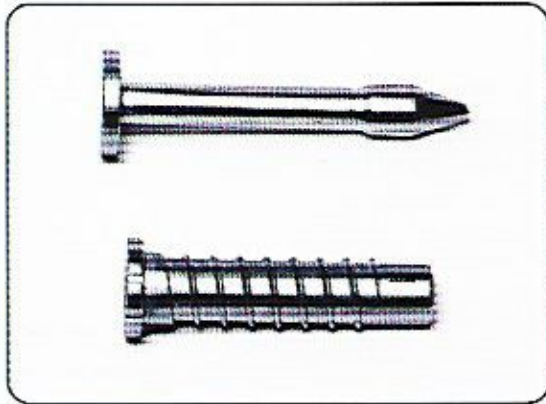

**VACTX 221**

Vaina para Cirugía de Tórax y trocar de 12,5 mm

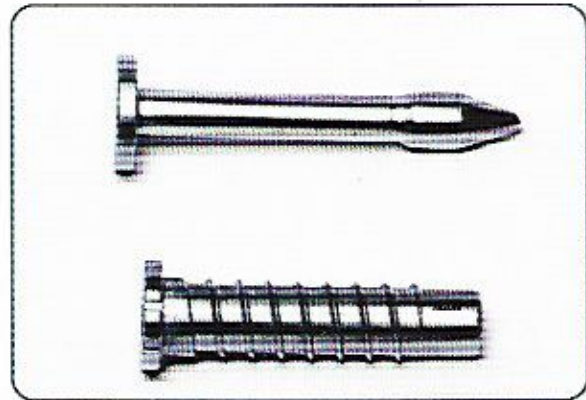

**VAINAS y TRÓCARES PARA ARTROSCOPIA**

**TRSPA 143** Trócar sin punta para Artroscopia, 4,3 mm x 187 mm

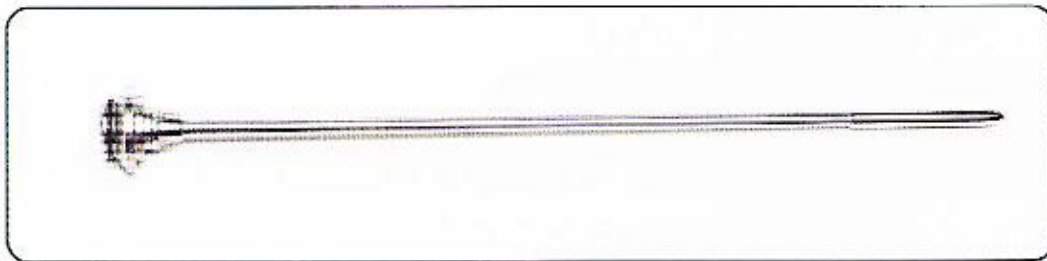

**TRCPA 143** Trócar con punta para Artroscopia, 4,3 mm x 173 mm



**VAART 155** Vaina para Artroscopia a 30°, 5,5 mm x 138 mm

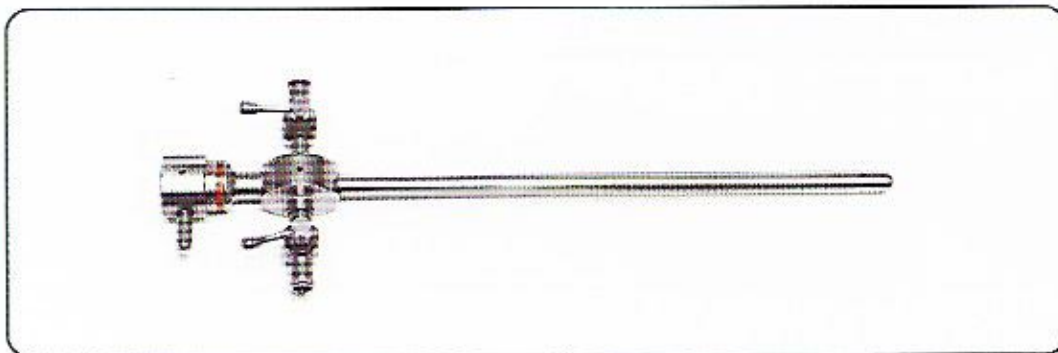

**CNIMF 250** Cánula Intrauterina Multifuncional

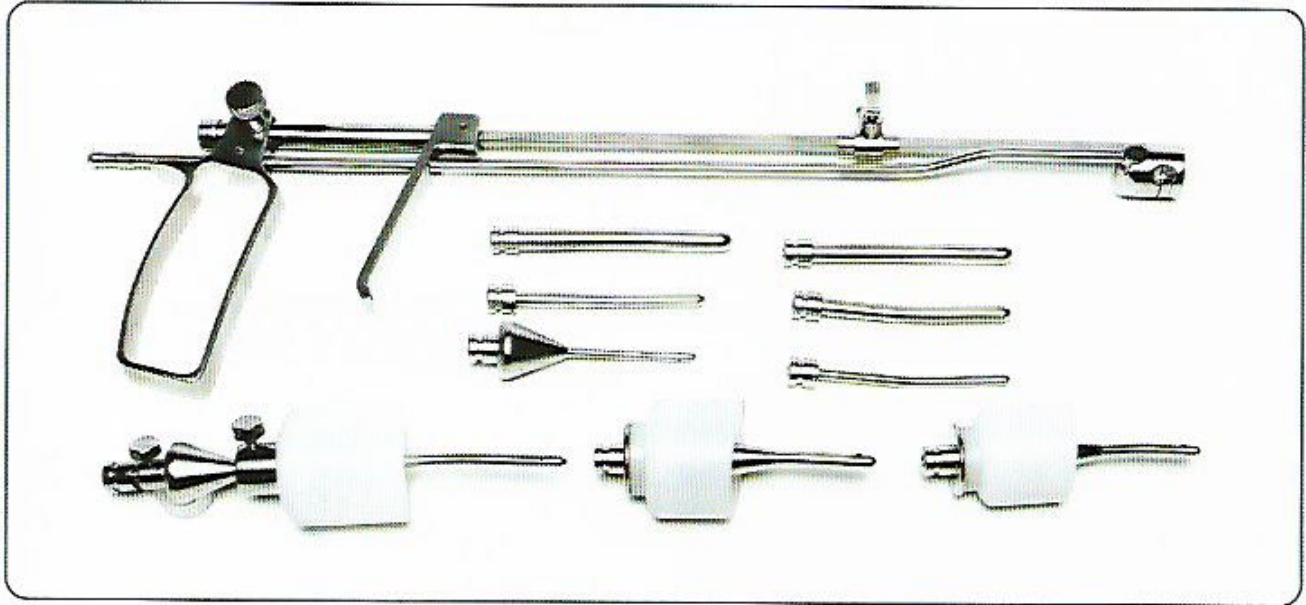

**CANULAS DE ASPIRACION E IRRIGACION**

**VLAIP 200** Válvula de aspiración e irrigación tipo trompeta con cánulas de 5 y 10 mm, 33 cm

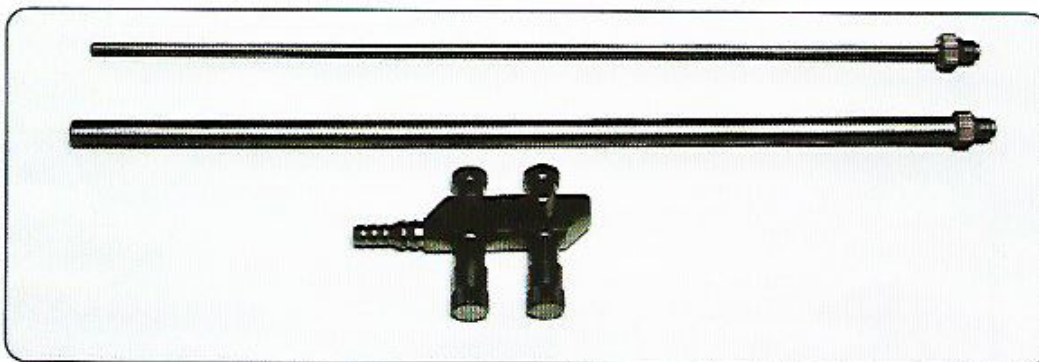

**CNAIV 201** Válvula de aspiración e irrigación con cánulas de 5 y 10 mm, 33 cm

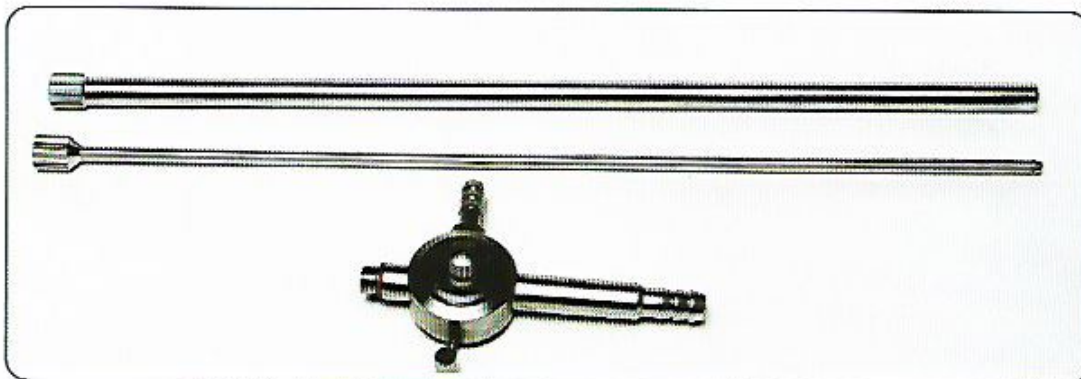

**SEP5R 210**

Separador 5 ramas con articulación a 45° 10 mm

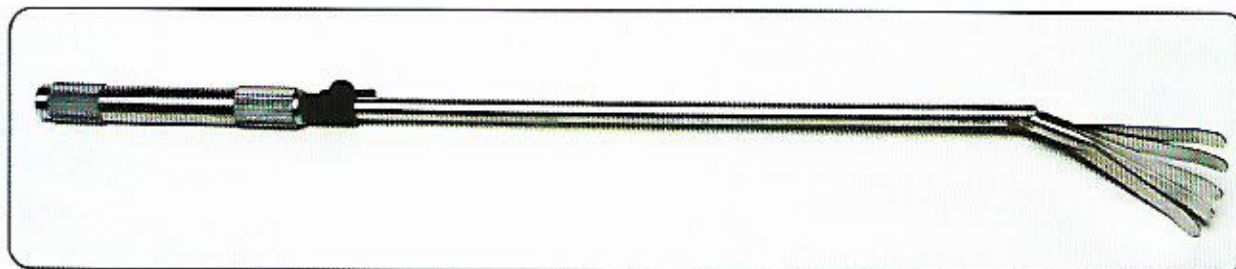
**SEP5R 250**

Separador de 5 ramas 5 mm 33 cm

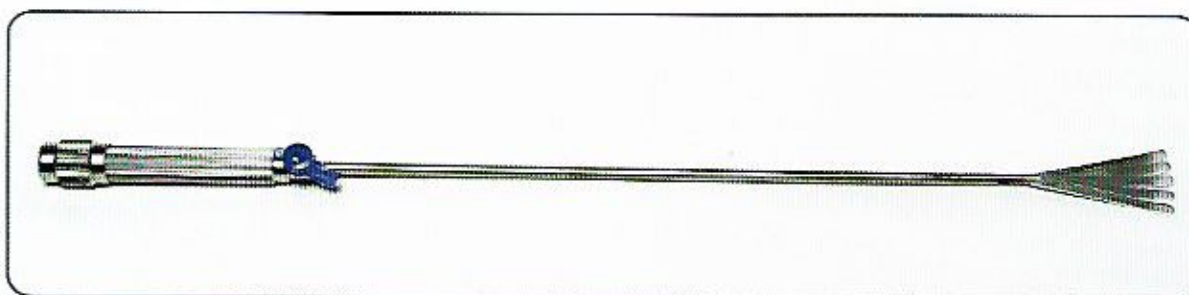
**SEFLM 250**

Separador flexible chico

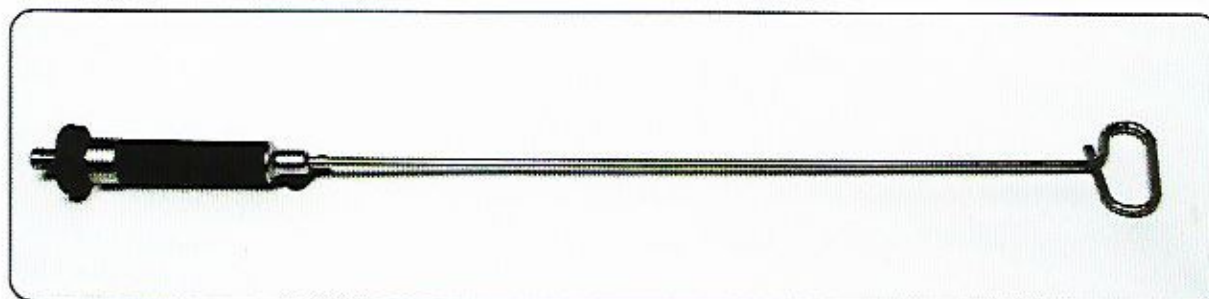
**SEFLL 250**

Separador flexible grande

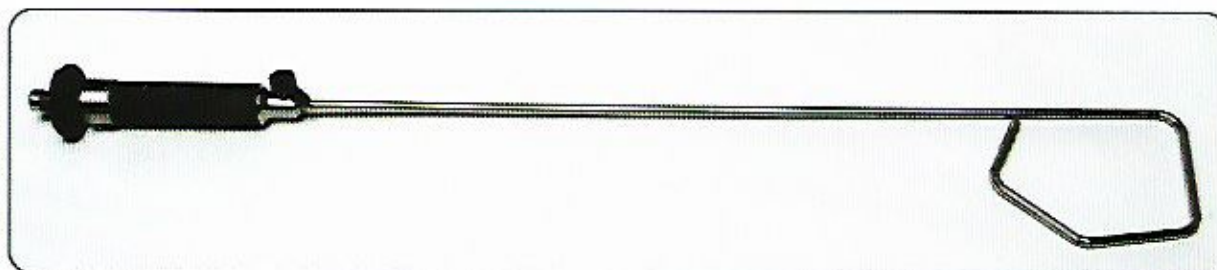

**BJEND 251**

Bajanudo 5 mm, 33 cm (aplicador de endoligadura)

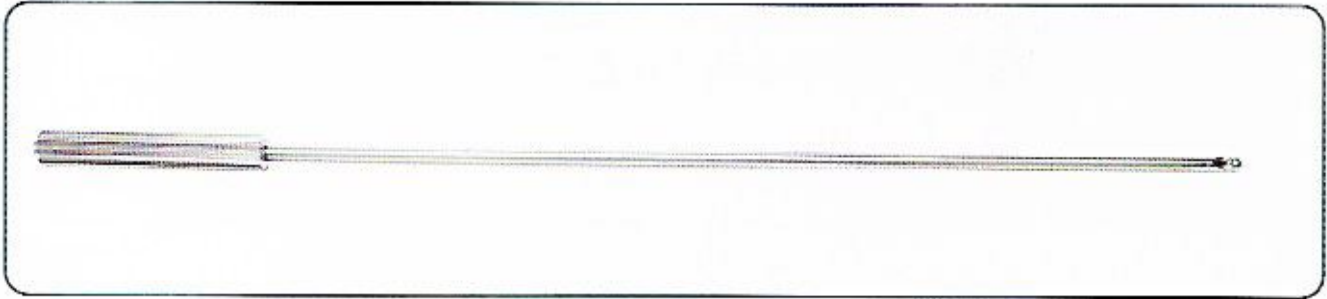
**BJEND 250**

Bajanudo 5 mm, 33 cm (aplicador de endoligadura)

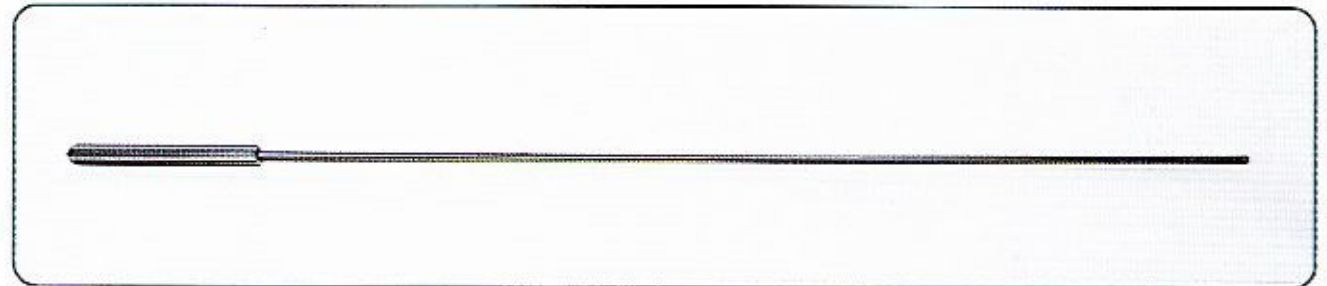



**OPT00 150** Óptica de 5 mm a 0°, 290 mm**OPT30 150** Óptica de 5 mm a 30°, 290 mm**OPT00 110** Óptica de 10 mm a 0°, 330 mm**OPT30 110** Óptica de 10 mm a 30°, 330 mm**OPT30 141** Óptica de 4 mm a 30°, 320 mm**OPT30 140** Óptica de 4 mm a 30°, 170 mm

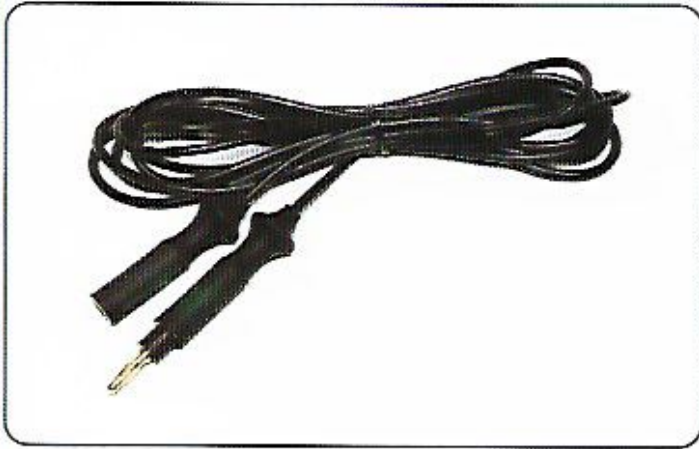

**CBMO3 203**

Cable monopolar Hook 3 mts

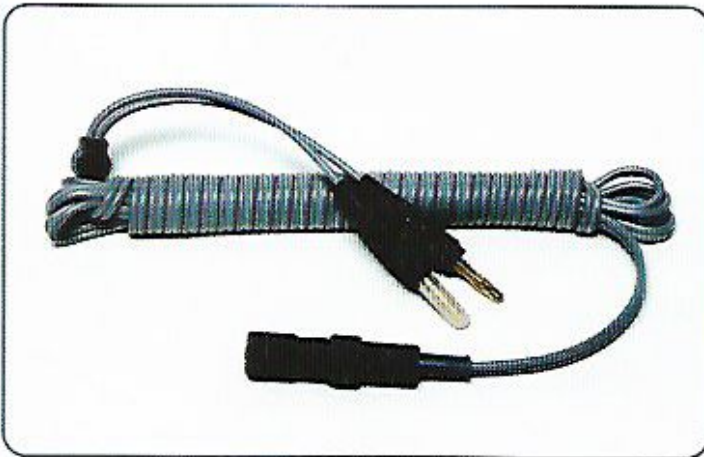

**CBBIP 203**

Cable Bipolar 3 mts

CABLES DE FIBRA ÓPTICA

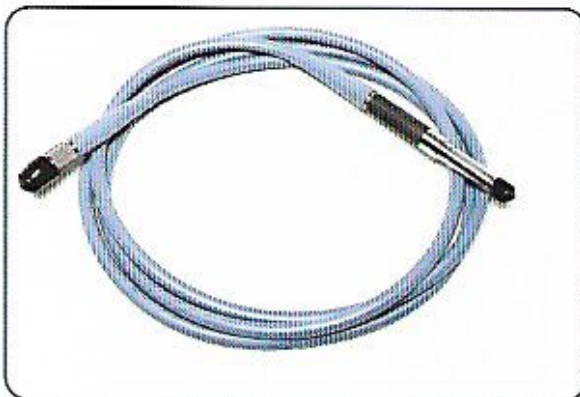

**CBFOP 202** Cable de fibra óptica 2 mts

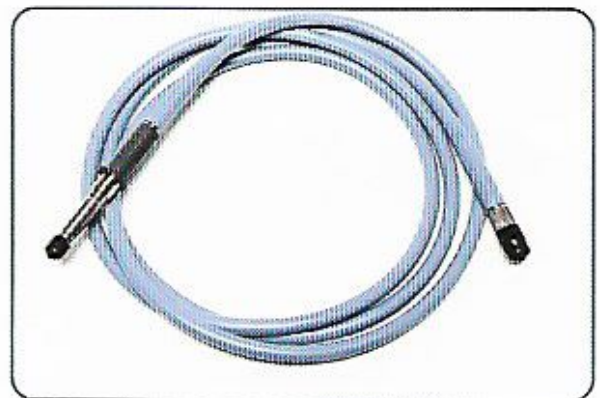

**CBFOP 203** Cable de fibra óptica 3 mts

**HST 100**

Histeroscopia

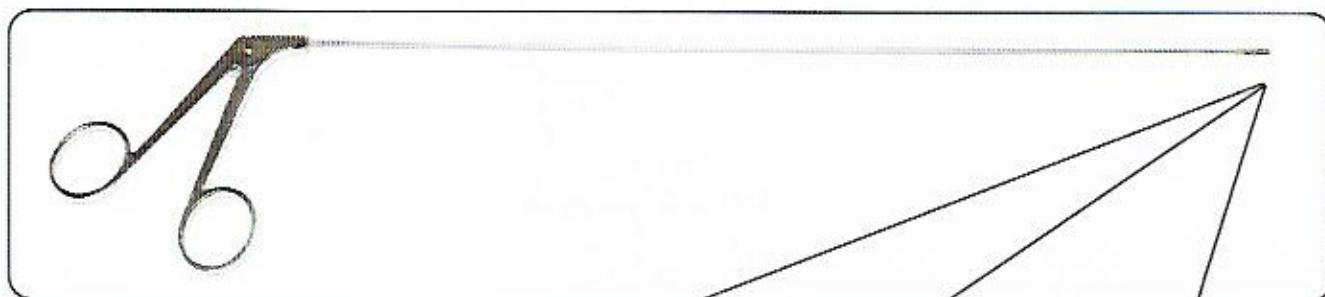
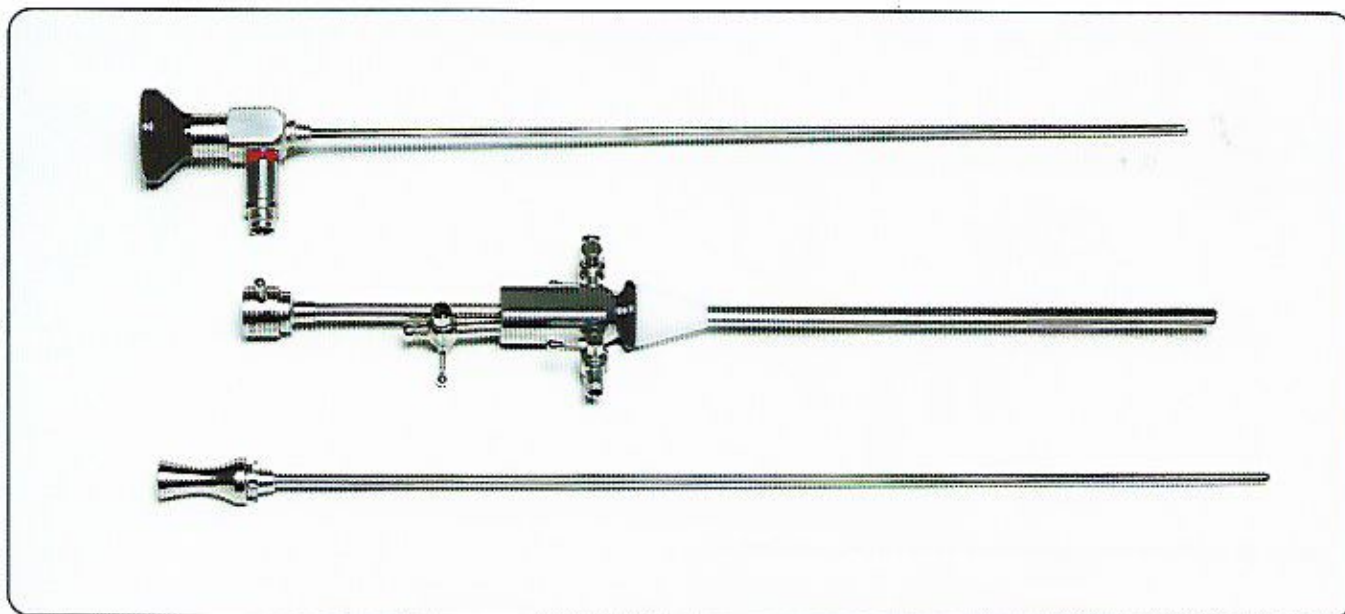

**TJRIG 100**

Tijera Rígida



**PZBIR 100**

Pinza para Biopsia Rígida



**PZAGR 100**

Pinza de agarre rígida

RSP 100

Receptoscopio

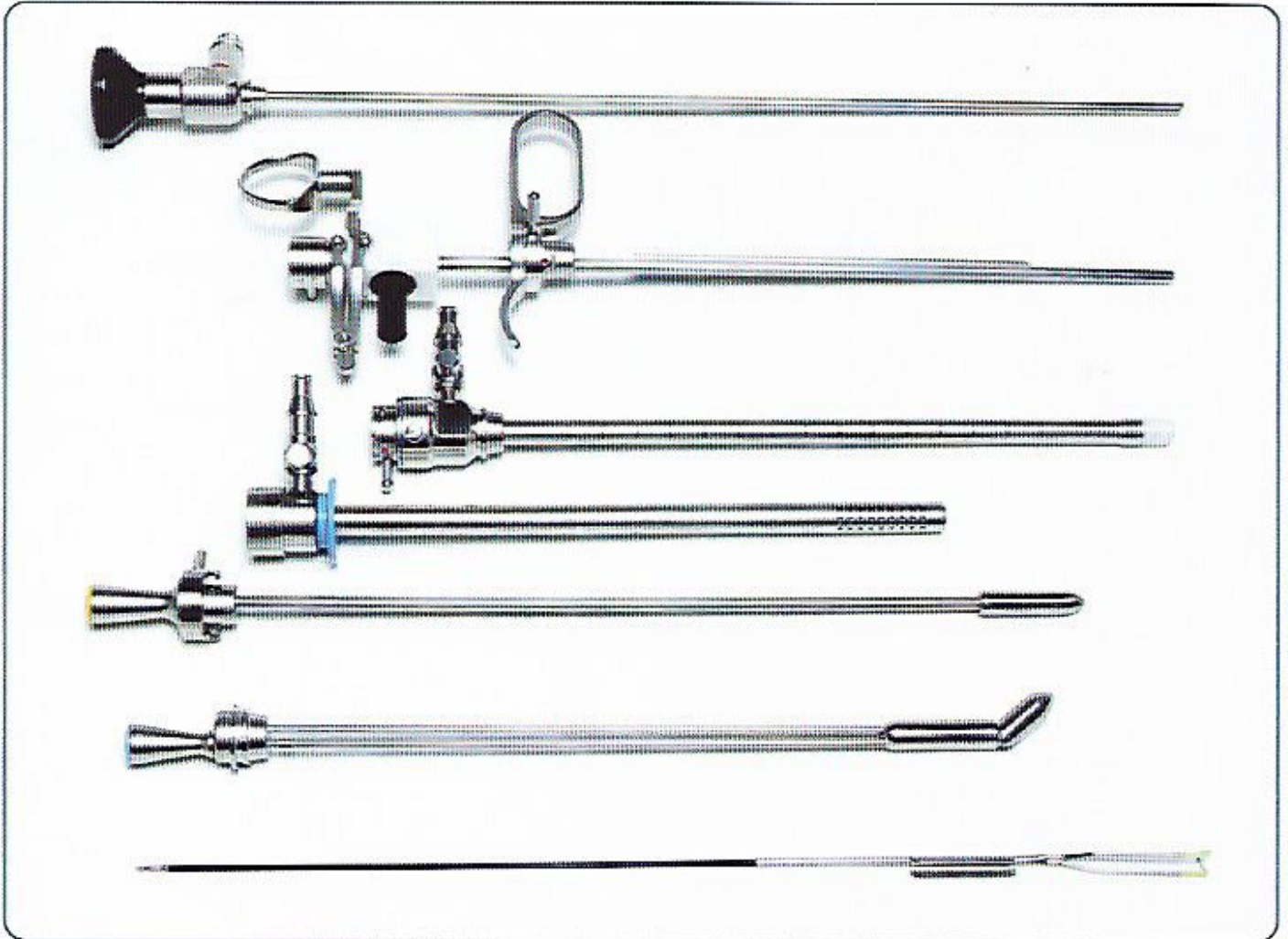

**PMPSC 100** Empuñadura plástica con cremallera, con conexión para electrocauterio



**PMPSC 101** Empuñadura plástica sin cremallera, con conexión para electrocauterio



**PTAIS 150** Tubo externo aislado para pinza 5 mm, 33 cm



**RPCO2 110** Silicona Externa Vaina 10 mm (5 unidades)

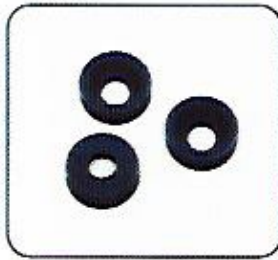

**RPCO2 150** Silicona Externa Vaina 5 mm (5 unidades)

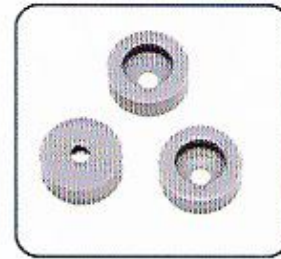

**RPCOV 110** Repuesto Silicona Interna Vaina Cierre Ventana 10 mm (5 unidades)



**RPCOV 150** Repuesto Silicona Interna Vaina Cierre Ventana 5 mm (5 unidades)

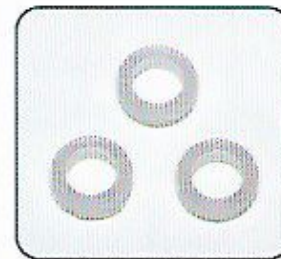

**RPCOV 111** Repuesto O'ring Interno Vaina Cierre Ventana 10 mm (5 unidades)



**RPCOV 151** Repuesto O'ring Interno Vaina Cierre Ventana 5 mm (5 unidades)

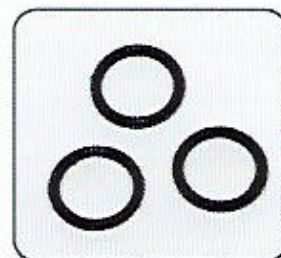

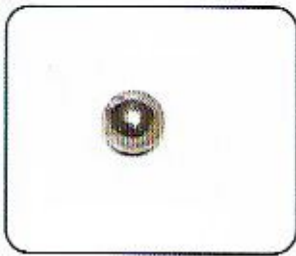

**RPMAG 150** Repuesto Bolilla Interna Vaina Magnética 5 mm (5 unidades)



**RPMAG 110** Repuesto Bolilla Interna Vaina Magnética 10 mm (5 unidades)

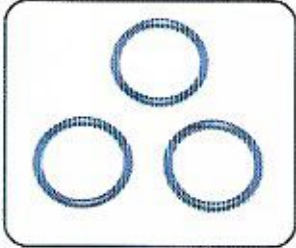

**RPMAG 111** Repuesto O'ring Interno Vaina Magnética 10 mm (5 unidades)

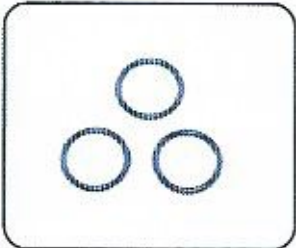

**RPMAG 151** Repuesto O'ring Interno Vaina Magnética 5 mm (5 unidades)



**RPMAG 210** Repuesto Moneda Interna Vaina Magnética 10 mm (5 unidades)

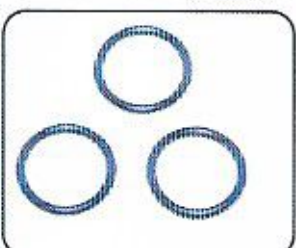

**RPMAG 211** Repuesto O'ring Interno Vaina Magnética 10 mm (5 unidades)

**CEP45 100**

Cepillo para limpieza set con 4 unidades 3 mm, 5mm, 10 mm y 15 mm de 45 cm de largo

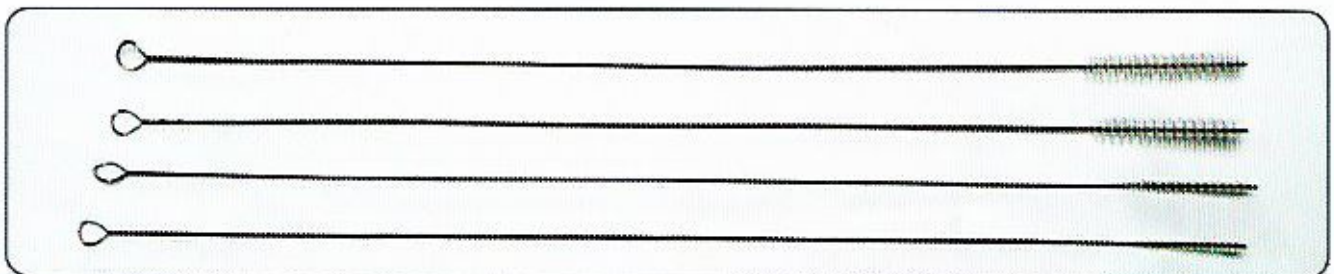



ENDOSCOPY



ENDOSCOPY

Av. Rivadavia 1479 6° B  
(54-11) 4383-0309/5440  
[info@endoscopy.com.ar](mailto:info@endoscopy.com.ar)